



Tetti piani



Triangoli in alluminio



Modulo in orizzontale



Supporto 10°**

KT0076

Sistema con supporto 10° per singolo modulo in orizzontale

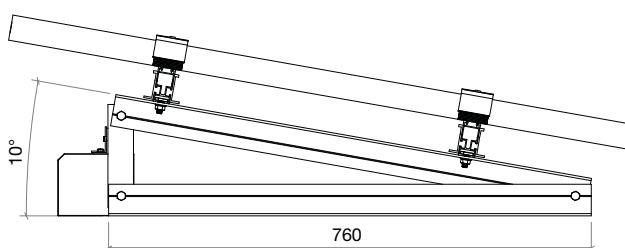

Caratteristiche Materiali

Nomenclatura: **EN AW 6060**;

Trattamento superficiale: **T5**;

Carico di rottura a trazione Rm (Mpa): **230**;

Carico limite di elasticità Rp 0,2 (Mpa): **200**;

Allungamento su 50 mm (%): **12**;

Durezza HB: **72**;

Coefficiente di dilatazione termica lineare tra 20°C e 100°C (1/°K): **23x10⁻⁶**;

Predisposizione al trattamento superficiale di ossidazione: **ottima**.

Caratteristiche Tecniche

Campo di applicazione: **Tetti piani**;

Orientamento modulo: **Orizzontale**;

Profilo installabile: **PRT2334, PRT2640, PRT2947**;

Collegamento al tetto: **Fissaggio o Zavorramento**;

Interasse medio triangolo con profilo PRT2334: **0,8 m***;

Interasse medio triangolo con profilo PRT2640: **1 m***;

Interasse medio triangolo con profilo PRT2947: **1 m***.

Certificazioni

Certificato: **ICIM N. 001DX/3**

Test report: **TECNO-LAB s.r.l.**



* I valori indicati per l'interasse possono variare a seconda dei cerichi vento e neve del sito di installazione.

** Disponibile con supporto 5° cod. **KT0076-5**

Profili compatibili e rispettive giunzioni

PRT2334-340 3400mm
PRT2334-113 1130mm

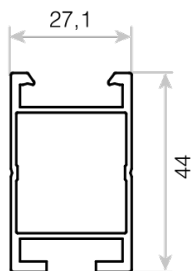

PRL3360

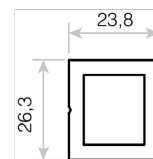

PRT2640-340 3400mm
PRT2640-113 1130mm

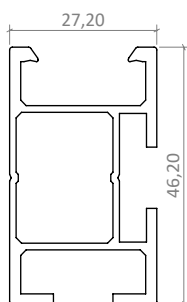

PRG2612

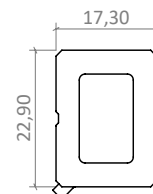
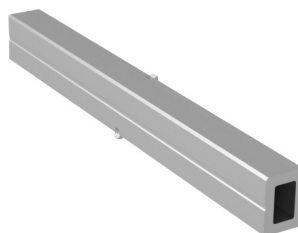

PRT2947-340 3400mm
PRT2947-113 1130mm

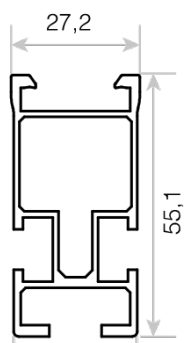

PRL2580

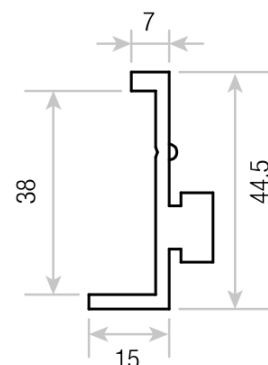

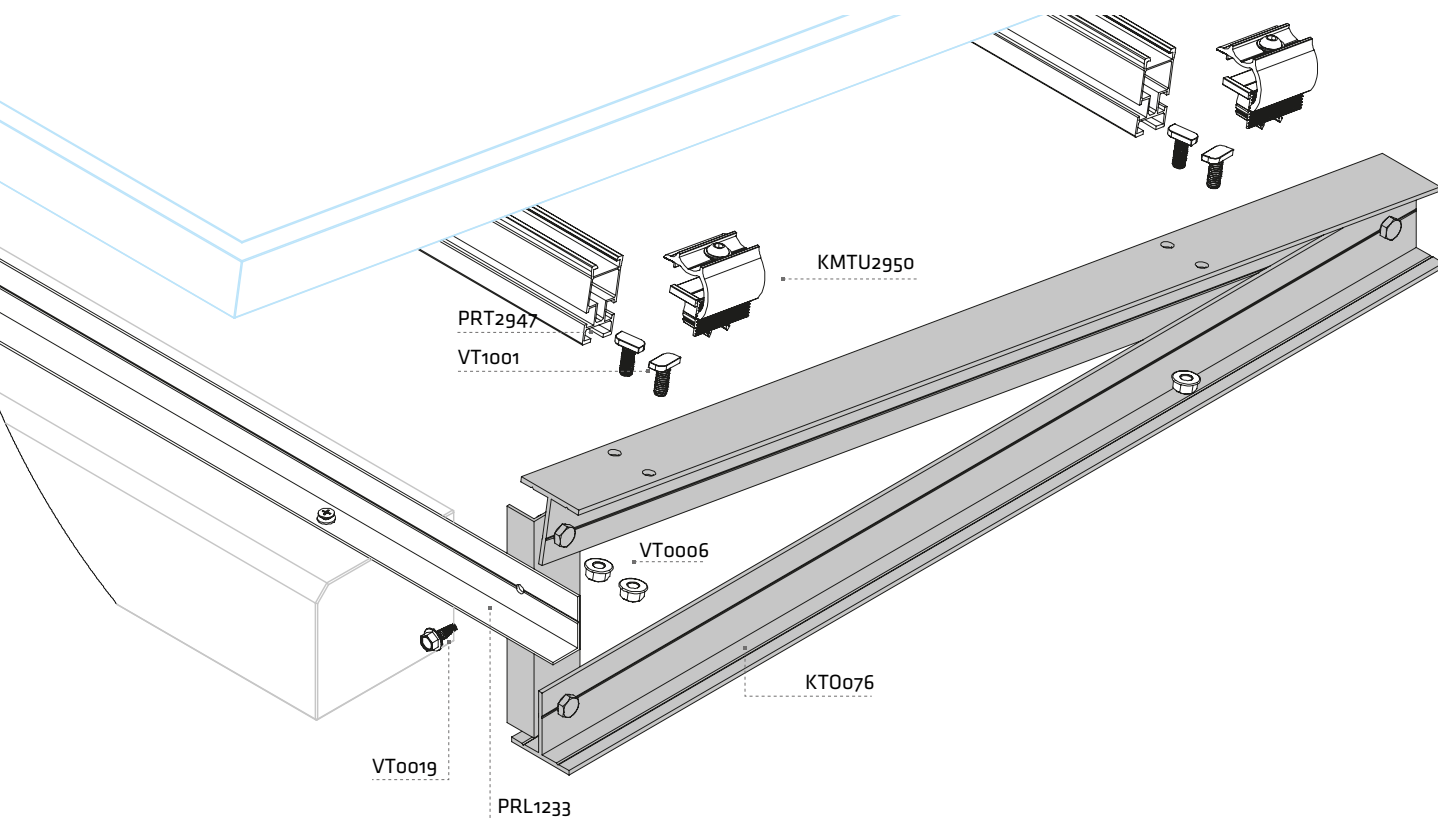

Accessori

KMCU2950
Universale centrale



KMTU2950
Universale terminale



VT0019
Vite auto perforante 6,3x25



PRL1233 3000 mm
PRL1233-200 2000mm

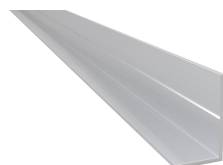

VT1001
Vite testa a martello M8x25



VT0006
Dado flangiato M8

